

CATIA CAD Application

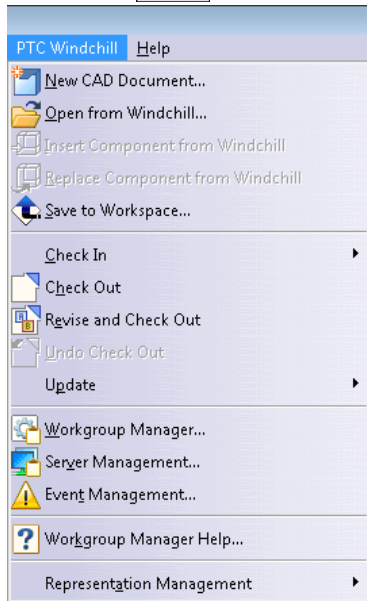

Windchill Work Group Manger

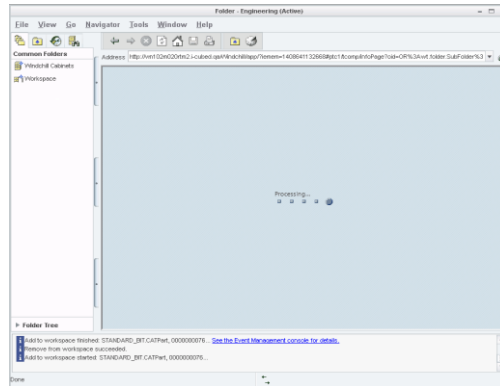

Workspace

PTC Windchill Repository

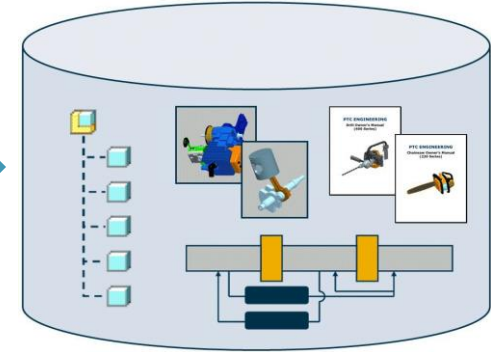

Commonspace

CATIA CAD Application

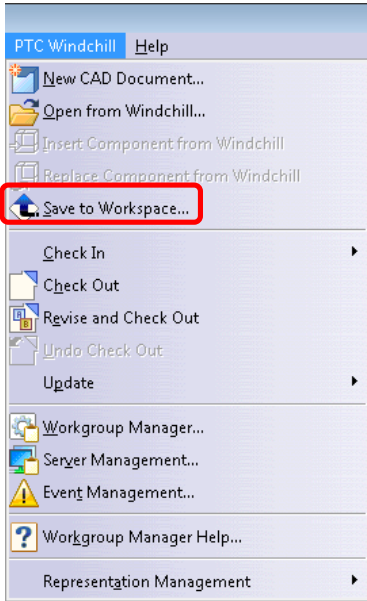

Set Active Workspace Save & Check In

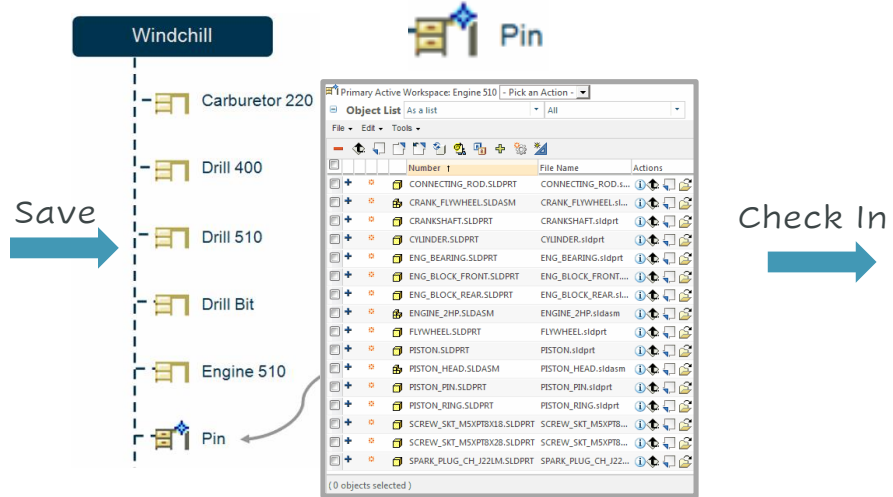

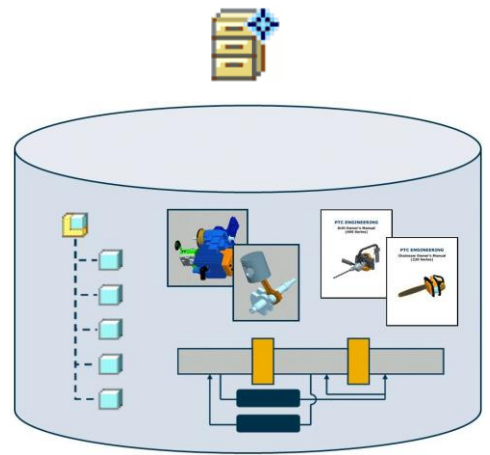

PTC Windchill Repository



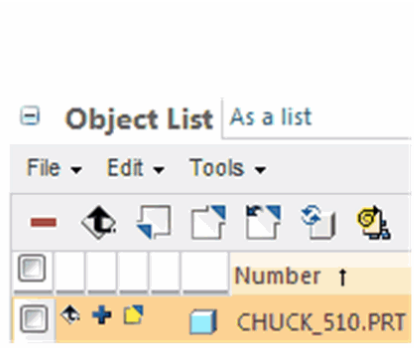
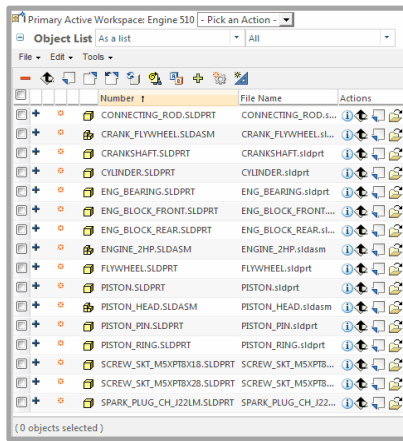

Workspace Status









Modified Status

-  Modified locally and upload needed
-  Modifications uploaded
-  Modified locally and not eligible for upload

Share Status

-  Shared to a project (PDMLink Only)
-  Shared from PDM (ProjectLink Only)
-  Checked out from PDM (ProjectLink Only)

General Status

-  New
-  Locked
-  Checked out by you
-  Checked out by you in another workspace
-  Checked out by another user
-  Another iteration is checked out by you
-  Another iteration is checked out by another user

Local Workspace Status

-  Modified locally

CATIA CAD Application

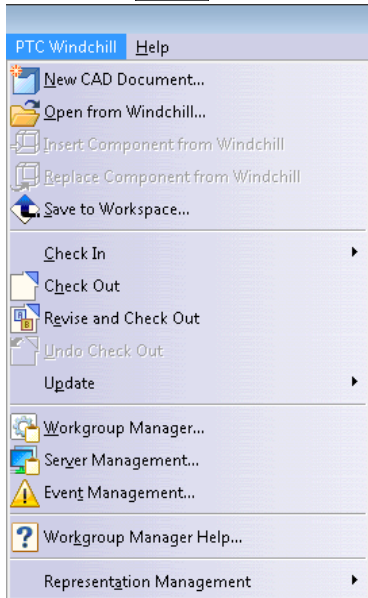

Save



Workspace Storage

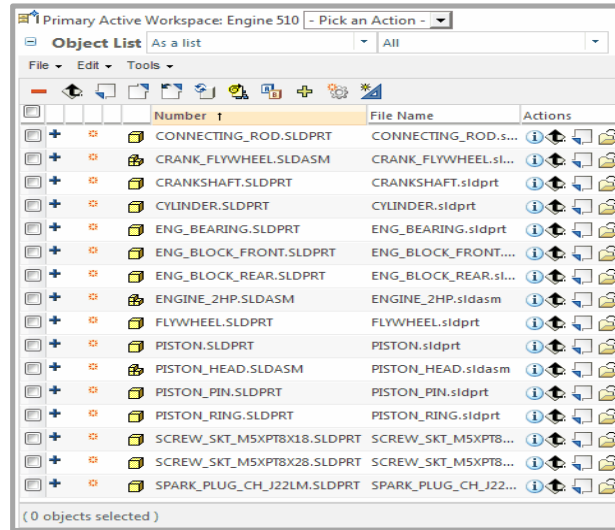

Client-side
Workspace

Server-side
Workspace

Check In



PTC Windchill Server

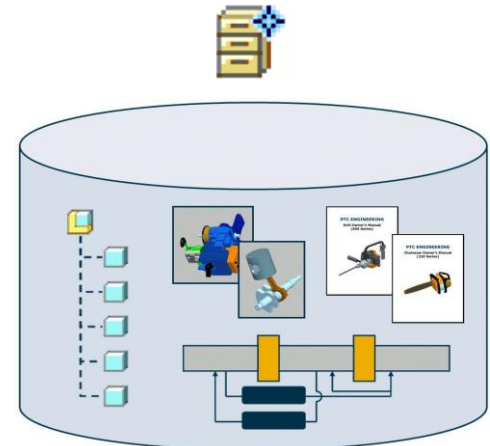

Working in Workspace

CATIA CAD Application



Client-side
Workspace

Session
Memory

Workstation Disk
(Local Cache)



Server-side
Workspace

Private
Folder

Shared
Folder

PTC Windchill
Server

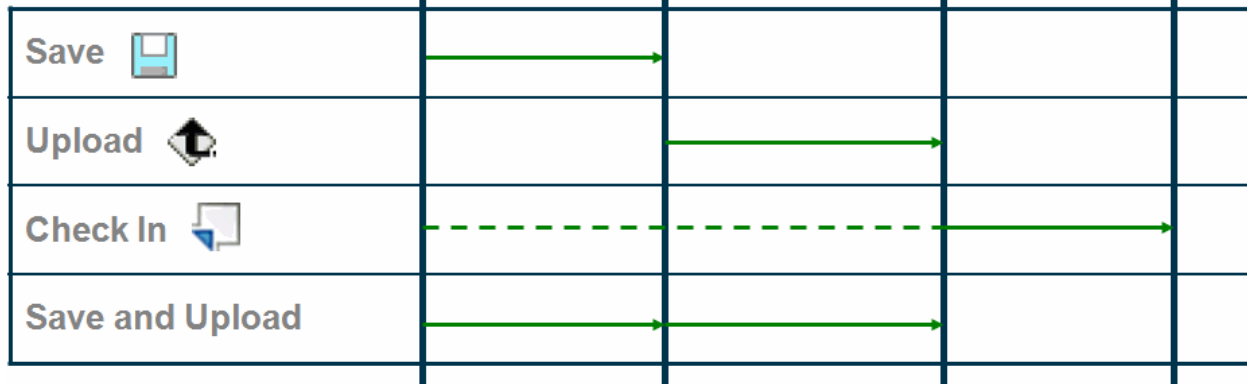

————— Primary Action

- - - - - Potential Action

CATIA CAD Information

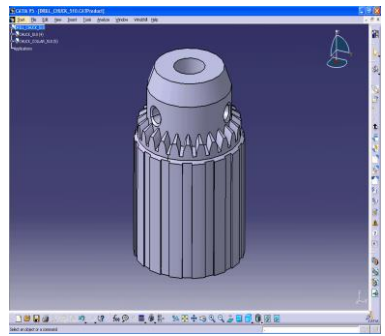

Workspace Information Page

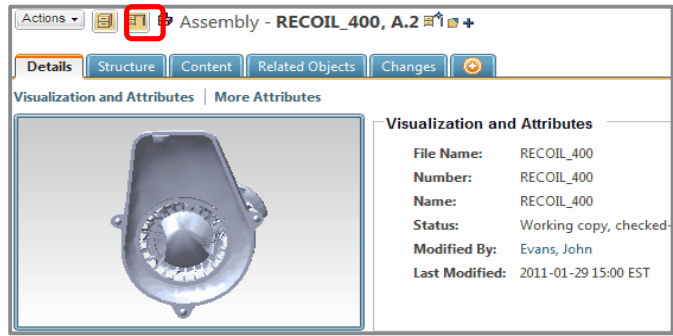

Commonspace Information

